

FDC12-180

Datasheet

FULBAT™

DEEP CYCLE BATTERY

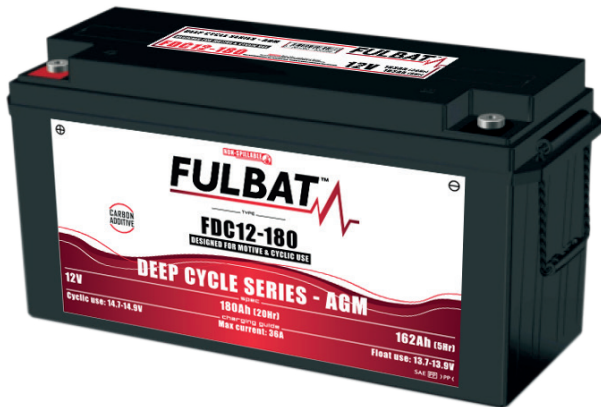

AGM



FDC Series are Deep Cycle AGM Carbon batteries specifically designed for frequent discharge deep cycle application. With non-spillable design and maintenance free, AGM FDC Series offer low self-discharge and ensure a maximum service life with high resistance to cycles. Thanks to carbon additives, these batteries can perfectly be used with good performance without being 100% charged. This range offers reliable performance for electric vehicle and other applications such as golf cart, aerial work platform, cleaning machine, marine, solar energy...

FEATURES

- Deep Cycle AGM technology (VRLA)
- Non-spillable & maintenance free
- No acid handling
- Deep Cycle design for high capacity and maximum life
- Reinforced grid/plates design for optimal cyclic use
- Robust, safe & reliable
- Carbon additives to perform in Partial State of Charge (PSOC) and to increase charging efficiency
- Low self-discharge rate for longer shelf life

TERMINAL

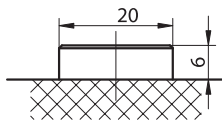
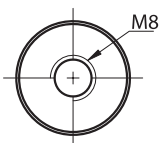

SPECIFICATIONS

Voltage	Capacity	Reserve capacity
12 V	194 Ah (100hr)	395 min (25A)
	180 Ah (20hr)	155 min (56A)
	174 Ah (10hr)	108 min (75A)
	162 Ah (5hr)	

OPERATING TEMPERATURE

Discharge	-15°C ~ 50°C
Charge	0°C ~ 40°C
Storage	-15°C ~ 40°C

CHARGING INSTRUCTIONS

Max current	36A
Float	13.7V - 13.9V
Cyclic	14.7V - 14.9V

DIMENSIONS & WEIGHT

Length	483±2mm
Width	170±2mm
Total Height	238.5±2mm
Gross weight	50.1kg

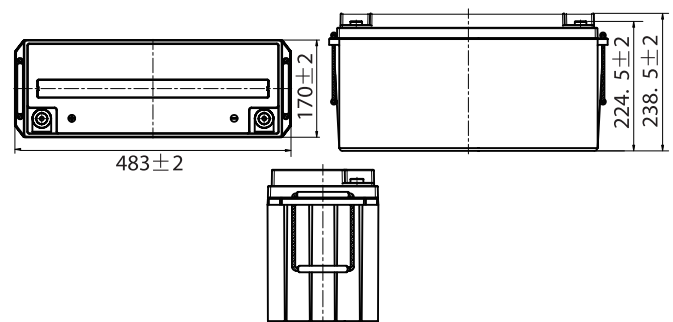

APPLICATIONS



Aerial work platform



Golf cart



Floor cleaning machine



Solar

FDC12-180

Datasheet



FDC AGM CHARGING PROFILE

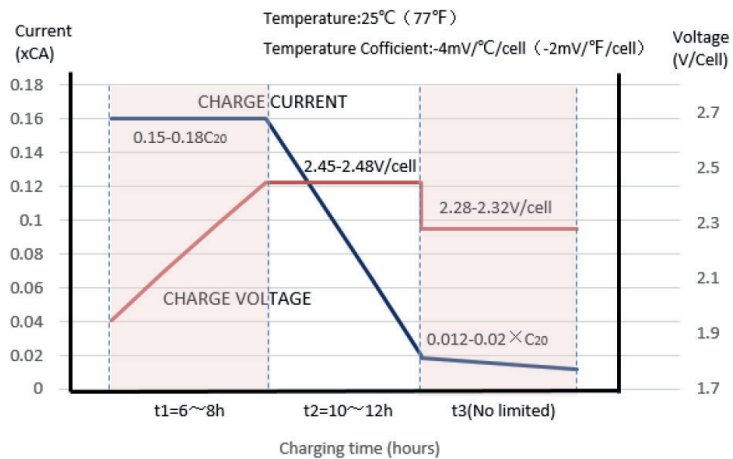

RELATIONSHIP OF OCV AND STATE OF CHARGE (25°C)

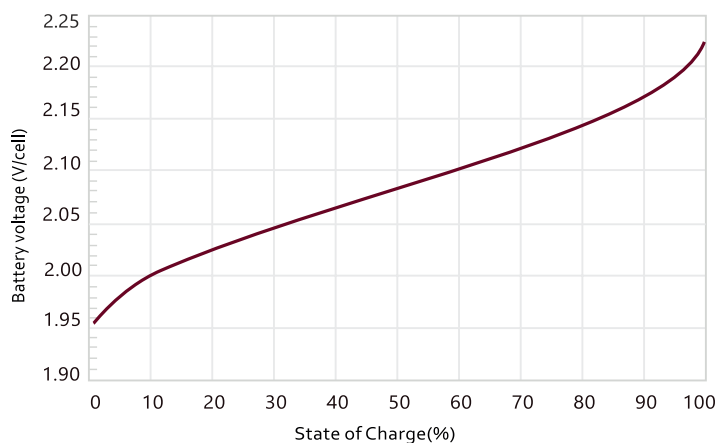

CYCLE LIFE IN RELATION TO DEPTH OF DISCHARGE

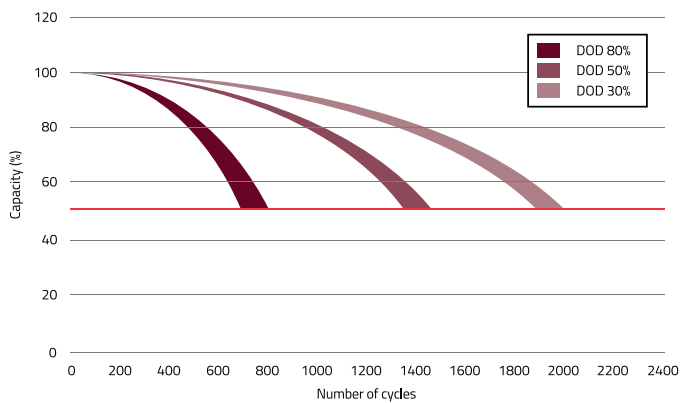

SELF-DISCHARGE CHARACTERISTIC

