

U1R-350

Datasheet



SLA

NON-SPILLABLE

SLA battery range is designed to offer maximum performance and safety! Ready to use, the Sealed Lead Acid (SLA) battery will not require any acid handling, initial preparation or maintenance.

The non-spillable design (VRLA) linked to its high performance make it the ideal battery for all ride-on mowers.

SPECIFICATIONS

Voltage
12 V

CCA
350A

DIMENSIONS & WEIGHT

Length	195±2mm	7.68 inch
Width	125±2mm	4.92 inch
Total Height	176±2mm	6.93 inch
Gross weight	6.70kg	14.77 lbs

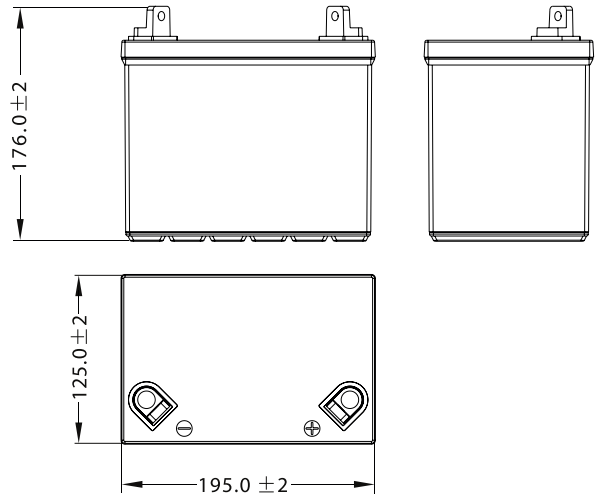

FEATURES

- AGM technology
- Ready to use
- Factory activated
- VRLA battery
- Non spillable: easy to ship
- No acid handling
- Easy to install and maintenance free
- Higher life cycle
- Minimized plate sulfation
- Suitable for cold weather

POLARITY



MOUNTING ANGLES



TERMINAL

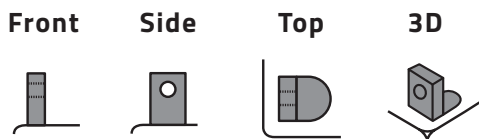

APPLICATIONS

