

# FPC12-60

## Datasheet

# FULBAT<sup>®</sup>

## CYCLIC BATTERY



# AGM



**NON-SPILLABLE**

FPC Series are deep cycle batteries specially designed for long duration cyclic applications, ie with use in charge and then intensive discharge. With advanced AGM valve regulated technology and oversized negative plates, the FPC Series ensure very good cyclic performance with greater depth of discharge for mobility-type applications such as medical, golf and also renewable energies storage.

In harsh use conditions (high temperature, higher deep of discharge...), the Gel FPG range is recommended.

### DIMENSIONS & WEIGHT

<b>Length</b>	229±2mm
<b>Width</b>	138±2mm
<b>Total height</b>	211±2mm
<b>Gross weight</b>	16.2kg

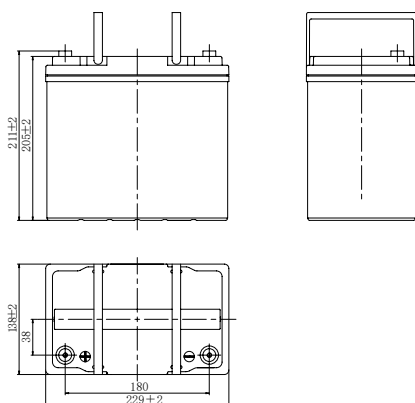

### TERMINAL

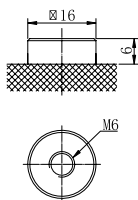

### SPECIFICATIONS

<b>Nominal voltage</b>	12V (6 cells)
<b>Nominal capacity</b>	55.0Ah (10hr)
<b>Cycle life</b>	
(50% capacity @20°C)	Up to 350 cycles at 100% DOD
(50% capacity @20°C)	Up to 800 cycles at 50% DOD
<b>Internal resistance</b>	Approx 9mΩ
<b>Terminal</b>	T6
<b>Max. discharge current</b>	1265A (5 sec)
<b>Reference capacity</b>	57.8Ah (20hr, 1.75V/cell, 25°C) 50.0Ah (5hr, 1.75V/cell, 25°C) 45.6Ah (3hr, 1.75V/cell, 25°C) 40.8Ah (2hr, 1.75V/cell, 25°C) 34.1Ah (1hr, 1.70V/cell, 25°C)
<b>Charge voltage</b>	
Standby use voltage	2.23V ~ 2.27V at 25°C Temperature compensation: -3mV/°C/Cell
Cycle use voltage	2.40V ~ 2.45V at 25°C Temperature compensation: -5mV/°C/Cell
<b>Operating temp. range</b>	Discharge: -20°C ~ 55°C Charge: 0°C ~ 40°C Storage: -20°C ~ 40°C
<b>Nominal operating temp. range</b>	25°C ± 3°C
<b>Self discharge</b>	Can be stored for up to 6 months at 25°C and then recharging is recommended. Monthly self-discharge ratio is less than 3% at 25°C
<b>Capacity affected by temp.</b>	40°C 103% 25°C 100% 0°C 86%
<b>Container material</b>	A.B.S. UL94-HB   UL94-V0 optional

### APPROVALS

ISO9001 - Quality management system  
 ISO14001 - Environmental management System  
 Approved for transport by Air (IATA)  
 Designed in accordance with IEC 60896-21/22

### APPLICATIONS



# FPC12-60

## Datasheet

### CONSTANT CURRENT DISCHARGE (A) @25°C

F.V./Time	1h	2h	3h	4h	5h	6h	8h	10h	20h
1.85V/cell	30.7	18.7	13.7	10.8	9.35	8.24	6.34	5.25	2.79
1.80V/cell	31.8	19.3	14.9	11.5	9.83	8.86	6.67	5.50	2.89
1.75V/cell	33.4	20.4	15.2	11.7	10.0	8.93	6.70	5.56	2.92
1.70V/cell	34.1	20.8	15.5	11.9	10.2	8.97	6.81	5.61	2.95

### CONSTANT POWER DISCHARGE (W/CELL) @25°C

F.V./Time	1h	2h	3h	4h	5h	6h	8h	10h	20h
1.85V/cell	59.4	36.4	26.8	21.1	18.4	16.3	12.6	10.4	5.55
1.80V/cell	61.2	37.4	29.0	22.5	19.3	17.4	13.2	10.9	5.74
1.75V/cell	64.0	39.2	29.5	22.8	19.6	17.5	13.2	11.0	5.79
1.70V/cell	64.9	39.9	29.9	23.1	19.8	17.6	13.4	11.1	5.84

### DISCHARGE CHARACTERISTICS

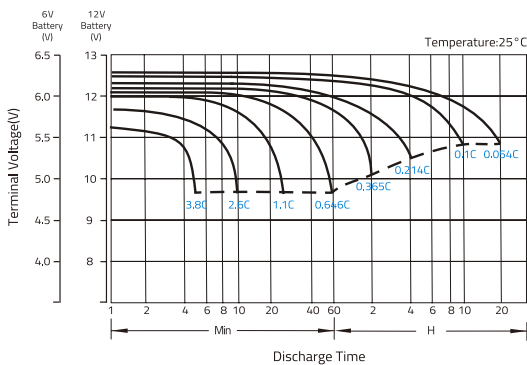

### FLOAT CHARGING CHARACTERISTICS

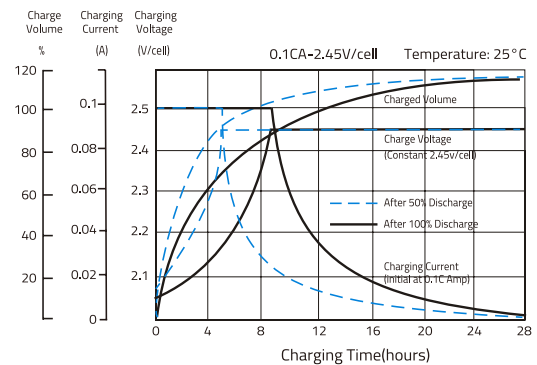

### TEMPERATURE IN RELATION TO BATTERY CAPACITY

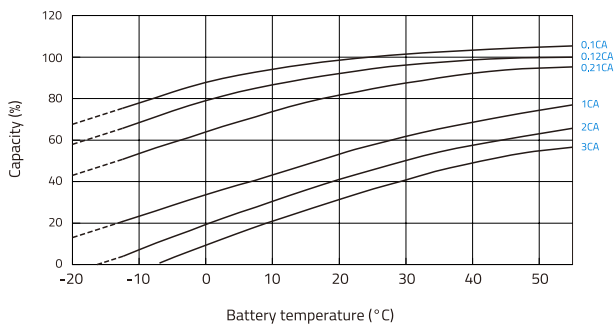

### CYCLE LIFE IN RELATION TO DEPTH OF DISCHARGE

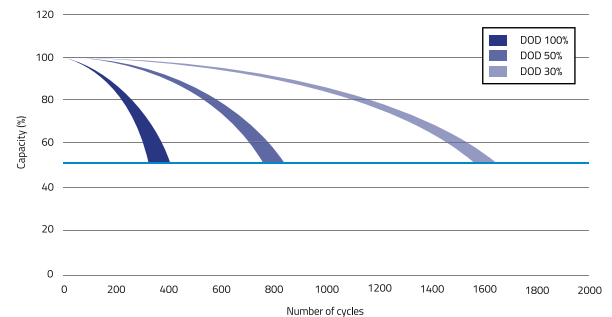

### SELF DISCHARGE CHARACTERISTICS

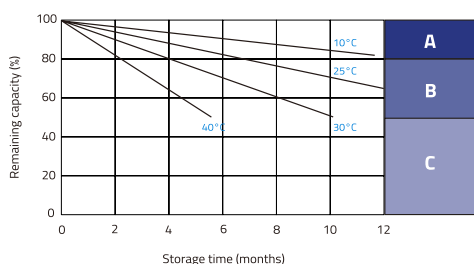

**A** No supplementary charge required  
(Carry out supplementary charge before use if 100% capacity is required.)

Supplementary charge required before use. Optional charging way as below:

- B**
- Charged for above 3 days at limited current 0.25CA and constant voltage 2.25V/cell.
  - Charged for above 20 hours at limited current 0.25CA and constant voltage 2.45V/cell.
  - Charged for 8-10 hours at limited current 0.05CA.

**C** Supplementary charge may often fail to recover the capacity.  
The battery should never be left standing till this is reached.